

## Canal équipé

Canaux équipés

Code: 3026 880



### DÉTAILS

Bord d'installation

Sous-plan

Matériau

Acier inoxydable AISI 304

Finition

Brossée Foster

Textures

Satiné

Base

120 cm

Dimensions extérieures

1138 x 170 mm

Dimensions intérieures

1122 x 122 mm

Largeur

113,8 cm

Longueur

8 unité - Standard

Trou d'encastrement

Voir fiche technique

---

Équipement standard

Crochets de fixation, vidange, emballage en boîte

---

Vidange

Vidange de 1¼"

---

Clé de lecture pour les accessoires

Les longueurs des canaux et des accessoires sont indiquées en "unités". Pour la composition, la somme des "unités" des accessoires doit correspondre à la longueur en "unités" du canal.

---

## DESSINS TECHNIQUES

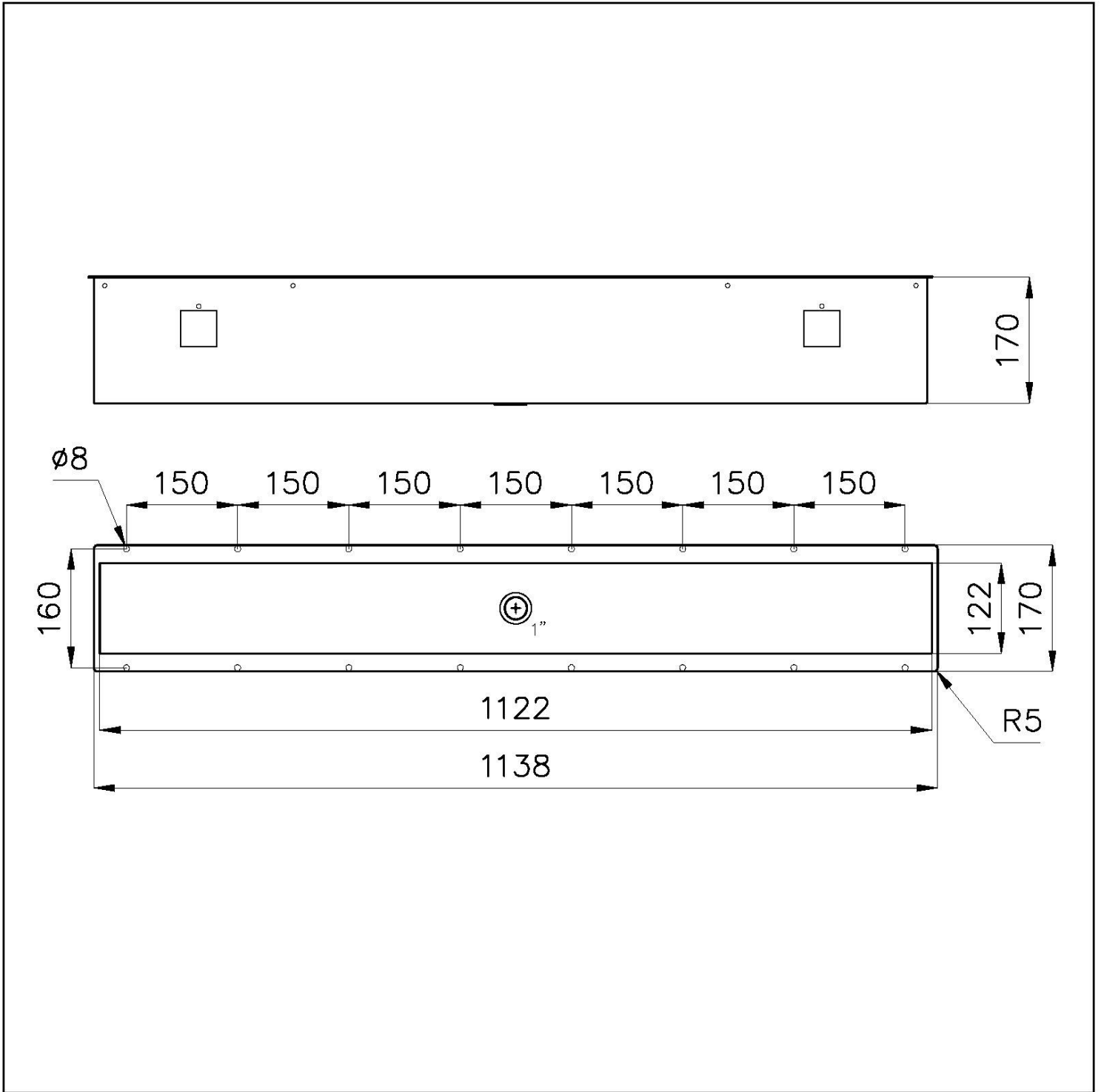

## Sottotop/Undermount

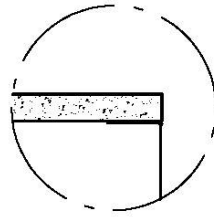

B-B:  
 Dettaglio installazione  
 Installation detail

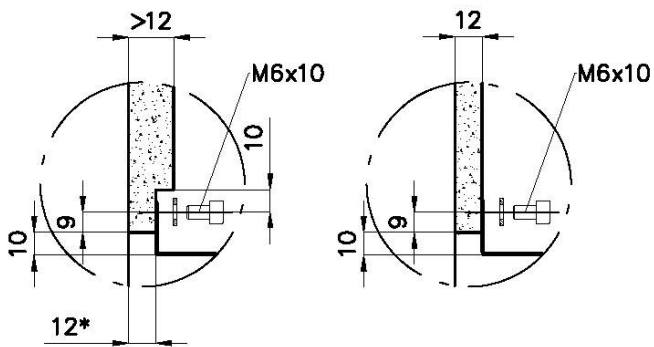

A-A:  
 Dettaglio installazione positive reveal e sistema di fissaggio  
 Installation detail with positive reveal and fixing system

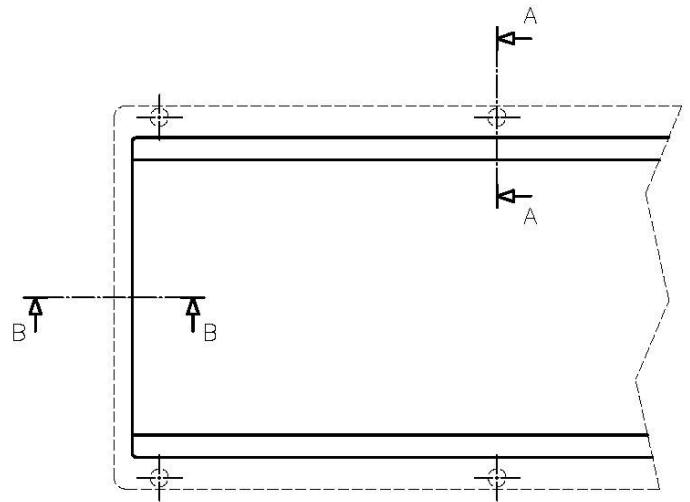

\*spessore consigliato per un abbinamento perfetto con gli accessori  
 \*recommended thickness for a perfect match with the accessories

Dimensioni per foratura top  
Cut out size

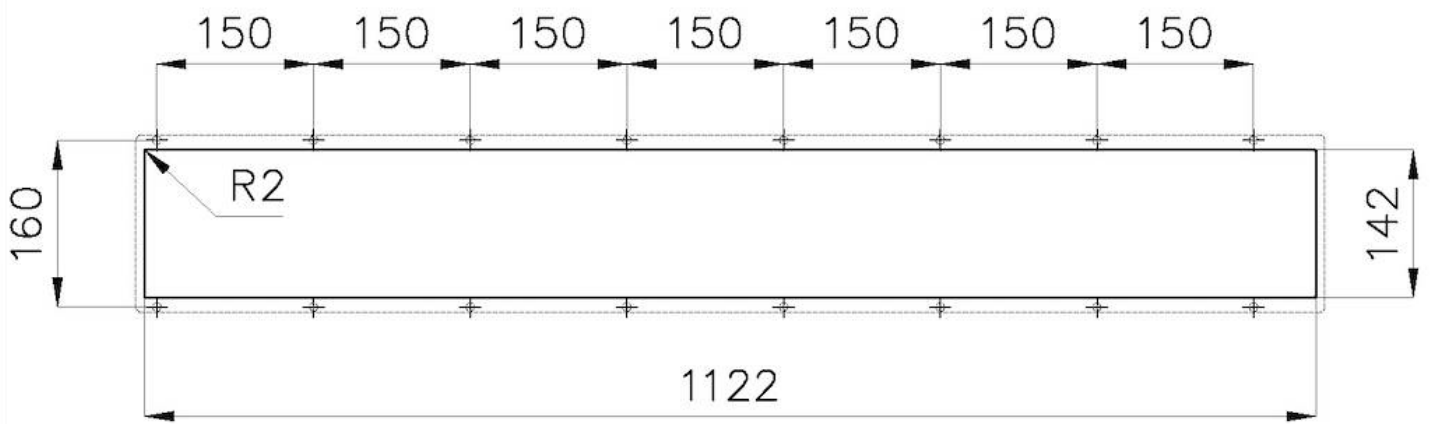

## GALERIE



## ACCESSOIRES OPTIONNELS



**Cuvette perforée en acier inoxydable**  
8151 003



**Kit "A"**  
8100 703



**Kit "B"**  
8100 700



**Kit "C"**  
8100 701



**Kit "D"**  
8100 704



**Kit "E"**  
8100 705



**Kit "F"**  
8100 706



**Kit "G"**  
8100 710



**Kit "H"**  
8100 702



**Kit "N"**  
8100 714



**Porte-assiettes inox**  
1773 100



**Porte-prises en acier inoxydable**  
8000 020



**Stainless steel knife holder**  
8100 712